

The following features are available  
in this PDF document.



### **Quick Keyword Search**

Enter the keyword in the search  
box and hit the search button



### **Quick Jump between Chapters**

Click the title of a specific chapter  
on the Contents to jump to it

\*Reading software such as Adobe Reader  
is needed in this case



# WEEBILL LAB

User Guide

# Contents

■ Packing List	
■ Get to Know WEEBILL LAB	
Get to Know WEEBILL LAB	2
■ Preparing and Charging the Batteries	
Charger and Battery Description	3
Charging Procedure	4
■ Installation	
Tripod Installation	5
Battery Installation	6
Camera Installation	6
Camera Control Cable Connection	7
■ Balance Adjustment	
Balance Adjustment	8
■ How to Use	
Buttons Description	10
OLED Screen Interface Description	12
Menu Option Description	13
Motor Torque Adjustment	14
Control Mode Description	15
Manual Angle Lock	17
■ APP Operations	
Image Transmission System and APP Operations	18
Download APP	18
How to Connect Stabilizer to Smartphone/Tablet	19
Overview of the Main Functions	19

<b>■ Calibration and Firmware Upgrade</b>	
When to Calibrate the Stabilizer .....	20
Initialization Method .....	20
Six-side Calibration .....	21
Motor Fine-tuning .....	22
Firmware Upgrade .....	22
<b>■ Product Specifications</b>	
<b>■ Disclaimer and Warning</b>	
Reading Tips .....	24
Warnings .....	24
Safe Operation Guidelines .....	25
<b>■ Warranty Card</b>	
Warranty Period .....	28
Exceptions .....	28
Warranty Claim Procedure .....	28

## Packing List

The product package comes with the following items. In case that any item is found missing, please contact ZHIYUN or your local selling agent.

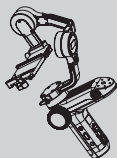

WEEBILL LAB Stabilizer x 1

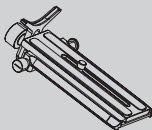

Quick Release Plate x 1



Tripod x 1



18650 Li-ion Battery x 2

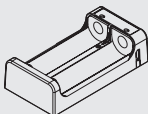

18650 Battery Charger x 1

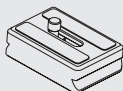

Camera Backing Base x 1



Micro USB Cable x 1



Type-C USB Firmware Upgrade Cable x 1



Micro USB Camera Control Cable x 1



Type-C Adapter x 1



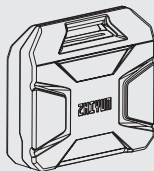

USB Cable Storage Box x 1

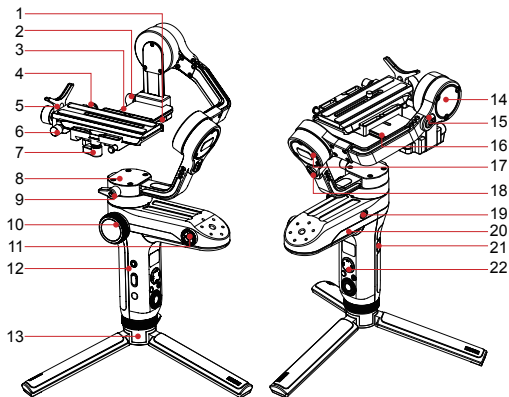

Storage Case x 1

Get to Know WEEBILL LAB



1. Camera Control Interface
2. Thumb Screw
3. Follow Focus Control Interface
4. Quick Release Button
5. Lens Support
6. Quick Release Lock Screw
7. Safety Lock
8. Pan Axis Motor
9. Thumb Screw
10. Focus/Zoom Control Wheel
11. 1/4" Screw Thread with Crown Gear
12. Side Buttons ([see more on Page 10](#) )

13. Tripod
14. Tilt Axis Motor
15. Tilt Axis Latch
16. Camera Control Module
17. Roll Axis Motor
18. Roll Axis Latch
19. Pan Axis Latch
20. Battery Compartment
21. Firmware Upgrade Interface
22. Control Panel ([see more on Page 10](#) )

When using WEEBILL LAB for the first time, please fully charge and activate the batteries with the dedicated charging device contained in the package to ensure normal use of the product.

### Charger and Battery Description

#### Charger Specifications

Name: 18650\*2 Li-ion Battery Charger

Model: ZC-18650-2

Input: 5V : 1600mA

Output: 4.2V : 800mA\*2

- Shines solid RED light when charging.
- Shines BLUE light when fully charged.

#### Battery Specifications

Name: 18650 Li-ion Battery

Model: IMR 18650 MP

Capacity: 2600mAh

Voltage: 3.6V

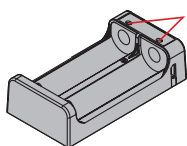

Status Indicator Light

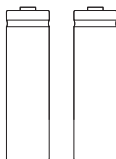

- ⚠** 1. The stabilizer is equipped with high-energy density batteries, which may cause fire, economic loss or personal injury when not properly used and stored. Please read the disclaimer and warning herein as well as the description on the battery label carefully before using the batteries.
2. Please use batteries provided or approved by ZHIYUN only. ZHIYUN will not take any responsibility for explosion, fire and/or accidents caused by non-ZHIYUN batteries.

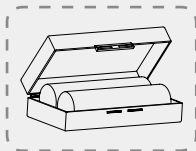

When the batteries are not in use, please be sure to put them in the battery slot of the package or in plastic storage cases (the storage case needs to be purchased separately).

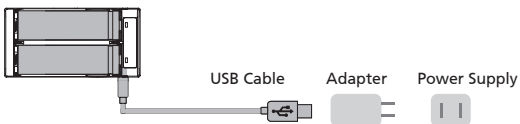

### Charging Procedure

1. Insert the batteries into the charger in the right direction (positive/negative end) accordingly.
2. Connect the charger to the adapter via the Micro USB cable.
3. Plug the adapter into an USB power outlet to start charging.



-  1. Battery charging may fail when the power supply is insufficient (for instance, when the current of the adapter is lower than 500mA). Conditions may vary depending on the specific chargers used. It is recommended to use an adapter with higher current capacity.
  2. The battery cannot be charged through the USB port on the stabilizer.
-  1. Please use qualified standard 5V/ $\geq$ 2000mA adapter for battery charging; charging time depends on the maximum input current of the adapter.
  2. This stabilizer comes standard with two high-discharge-rate dedicated batteries. Please use and charge batteries provided or approved by ZHIYUN only.
  3. Please make sure both the batteries are fully charged. Either battery under charged can lead to failure of the stabilizer.



Each axis of the gimbal is equipped with a latch. You can use these latches to lock the axes for convenient installation and storage.

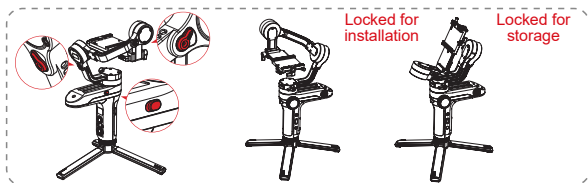

### Tripod Installation

Get the tripod ready and mount it to the 1/4"-3/8" threaded hole at the bottom of the stabilizer, then unfold the tripod on a flat surface.

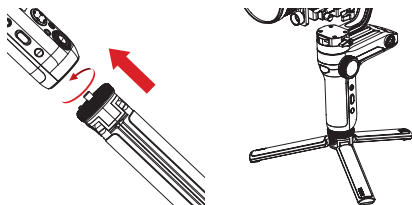

You can also install the tripod onto the base of battery compartment to enter Sling Mode.

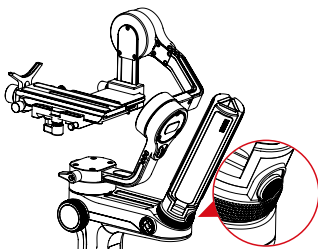

**⚠** Be sure to put the tripod lock switch to lock position before entering into Sling Mode.

## Battery Installation

Slide out the cover of the battery compartment and load two ZHIYUN 18650 lithium batteries (note the positive and negative directions).

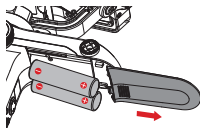

## Camera Installation

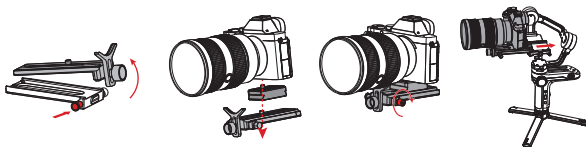

- Take out the quick release plate module and press the Quick Release Button to take out the Arca quick release plate.
- Mount the camera on the backing base as above, then mount it on the quick release plate and tighten the 1/4" screw at its bottom.
- Adjust the lens support on the quick release plate to support the lens and ensure it is stable.
- Mount the installed quick release plate into the quick release module, and then install and lock the whole module on the three-axis stabilizer.

-  1. Before mounting the camera, make sure it is prepared ahead of time. Remove the lens cap and make sure the camera's battery and memory card are already in place.
2. The backing base is needed when the size of the lens outranges the bottom of the camera. You can decide whether to install the backing base according to the actual situation.

### Camera Control Cable Connection

Connect the two ends of the camera control cable included in the package to the control interface of the camera and stabilizer.

Interface Type	Micro USB	Type-C
Camera Model	Sony a6300	Panasonic GH5
Photo	√	√
Video	√	√
AV	√	√
TV	√	√
ISO	√	√
EV	√	√
Image Transmission	√	√

1. If the camera uses type-c interface control, please connect with the type-c adapter included in the package.
2. The list above is based on Sony a6300 and Panasonic GH5. For compatibility with other cameras, please refer to our official website or consult customer service.
3. Please charge the camera through the camera control interface. If your camera has sufficient power and does not require direct charging with the stabilizer, please turn off the USB power supply option of the camera to save power of the stabilizer.

### Balance Adjustment

💡 To facilitate the adjustment procedure, we recommend locking the three axes of WEEBILL LAB the way as camera-mounted state, then unlock and make balance adjustment of the axes one by one.

- 1 Unlock the tilt axis and the camera locking latch, push the camera to move forward or backward until the camera can stay still and almost level with its lens facing front (as shown on the right). Complete this step by tightening up the camera mounting thumb screw.

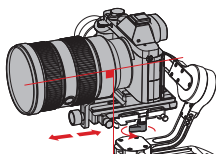

💡 Push the safety lock up if it sticks.

- 2 Make the lens face up, slightly loosen the thumb screw of the tilt axis, push the camera to move upward or downward until the camera can stay still with the lens facing up (i.e. the camera stays still and vertical to the ground as shown on the right). Complete this step by tightening up the thumb screw.

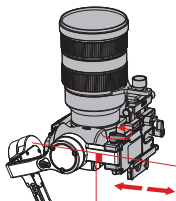

- 3 Unlock the roll axis, slightly loosen the thumb screw at the bottom of the quick release plate, push the camera to move left or right until the camera can stay still and horizontal to the ground (as shown on the right). Complete this step by tightening up thumb screw.

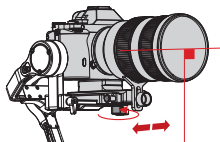

- 4 Unlock the pan axis, slightly loosen the thumb screw on it, then adjust the pan axis until it stays still and horizontal to the ground (as shown on the right). Complete this step by tightening up thumb screw.

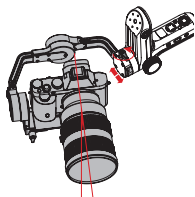

-  If the camera hinders rotation of any screw, please pull up and turn round the screw, then rotate again to tighten up.

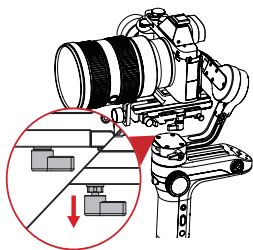

-  Before turning on the stabilizer, make sure the three motors are unlocked and can move freely. Turning on the stabilizer in locked state will lead to overheating and damage of the motors.

## Buttons Description

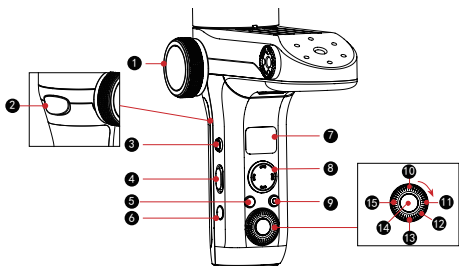
**1** Focus/Zoom Control Wheel\*

Once connected to the servo follow focus motor, the focus/zoom control wheel on the gimbal will be able to drive the follow focus motor.

**2** Following Mode

- Press to enter into F (Following) Mode
- Double press to reset the motor position
- Triple press to realize 180° rotation on pan axis motor

**3** PhoneGo Mode [ **GO** ]

Press the GO button to enter PhoneGo Mode which enables faster following speed of the three axes on the stabilizer.

**4** Mode Switch

- Dial up and the stabilizer enters into PF (Pan Following) Mode.
- Dial down the stabilizer enters into L (Locking) Mode.

**5** POV Mode [ **POV** ]

- Click to enter POV mode (Point of View).
- Double press to enter or exit V (Vortex) Mode.
- Long press for 2 seconds to enter or exit standby Mode.

**6** ON/OFF [  ]

Long press for 2 seconds to power on/off the stabilizer.

**7** OLED Display

Stabilizer status and camera parameters ([see more on Page 12](#) )

\*When the stabilizer is properly installed with the follow focus CMF-04 (needs to be purchased separately), the focus or zoom control function can be achieved by installing the gear ring on either the focus or zoom channel of the lens. WEEBILL LAB does not support synchronous zoom & focus control.

### 8 Joystick

Four-way direction control of the camera / lens on the stabilizer.

### 9 Video [ ● ]

Single press to start/end video recording.

### 10 LV Button [ LV ]

- Double click LV to lock front buttons.
- Triple click LV to lock all buttons.
- Double click again to unlock all buttons.

### 11 Right[ ► ]

- In main screen, single press to move to next option.
- In menu screen, single press to confirm selection.

### 12 Dial

- In main screen, rotate the dial to adjust camera parameters.
- In menu screen, rotate the dial to switch between options.

### 13 Menu[ ... ]

Single press to enter or exit menu screen.

### 14 Shutter Release

- Halfway press the button to activate auto focus.
- Full press the button to take single shots.

### 15 Left [ ◀ ]

- In main screen, single press to move to previous option.
- In menu screen, single press to return to previous screen.

- 💡 1. When powering on the stabilizer, please loose hold the camera with one hand in case of malfunctioned rotation.
- 2. When powering on, avoid shaking of the stabilizer which may lead to start-up failure.

## OLED Screen Interface Description



Display screen with camera params settings







Display screen with stabilizer modes (camera params settings unavailable)



Menu Screen

Icon Description :

	Camera Connection Status
	Video Mode
	Photo Mode
	Battery Level (stabilizer)
PF	Pan Following Mode
L	Locking Mode
POV	Point Of View Mode
F	Following Mode
GO	PhoneGo Mode
V	Vortex Mode
AV	Aperture Value
TV	Shutter Speed Value
ISO	ISO
	EV



## Menu Option Description

motor (Motor Torque Setting)	low	Low-torque		
	medium	Medium-torque		
	high	High-torque		
wheel (Control Wheel Setting)	sensi (control wheel sensitivity)	low	Low Sensitivity	
		medium	Medium sensitivity	
		high	High Sensitivity	
	ABpoint (AB Point) <sup>1</sup>	Max	A	Set the current wheel position as A point
			B	Set the current wheel position as B point
			clear	Clear AB Points
		Lite	A	Set the current wheel position as A point
			B	Set the current wheel position as B point
			clear	Clear AB Points
	priority (Priority on Wheel)	handle	Prioritize handle control	
		external	Prioritize external control <sup>2</sup>	
		off	Disable handle wheel (control wheel on the stabilizer)	
	reverse (Reverse)	Control the wheel in reverse direction		
joystick (Joystick Setting)	reverse (Reverse)	vertical	Joystick in vertical direction	
		horizontal	Joystick in horizontal direction	
calibration (Calibration Setting)	yes	Enter six-side calibration		
	no	Exit calibration setting		
angle (Fine-tuning on motor angle)	pitch	Fine tune the tilt axis motor		
	roll	Fine tune the roll axis motor		
about	Information of firmware versions, WIFI and name of Bluetooth (press right to find out which version of image transmission system the stabilizer is running)			

 "1" AB point settings are only available when connecting to ZHIYUN Servo Follow Focus correctly.

"2" External control refers to remote control via Bluetooth or cable controls other than local controls via the stabilizer. (Remote Control needs to be purchased separately).

## Motor Torque Adjustment

The motor torque of the stabilizer shall be adjusted by 3 levels to adapt to the specific camera and lens applied for ideal performance.

How to adjust :

● motor  
wheel  
joystick

1. Single press Menu and rotate the dial to "motor", then press right to enter motor torque setting.

● low  
medium  
high

2. Rotate the dial to choose the appropriate motor force and press right to confirm the option.

Motor Force	Weight Capacity	Examples of Compatible Camera & Lens
low	Low	Sony rx 100 series or pocket camera
medium (default)	Medium	Sony A6500+FE35 f2.8
high	High	Sony A7R3+FE24-70 f4

**⚠** Either the motor force is set too high or too low (unmatched with weight capacity) can lead to camera shake and affect normal use of the stabilizer.

## Control Mode Description

 Motors circled in red will auto move with the stabilizer, while motors circled in grey are locked instead of moving with the stabilizer.

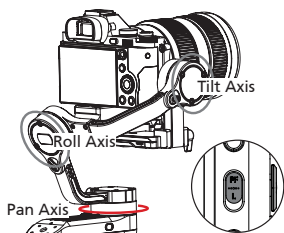

**Pan Following Mode (PF):** Push up the PF/L mode switch

The camera pans left/right following the movement of the stabilizer while the tilt and roll axes are locked. Push the joystick up/down allows manual control of the tilt axis.

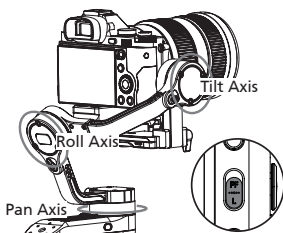

**Locking Mode (L):** Push down the PF/L mode switch

This mode locks the movement of all three axes to keep the camera fixed on a shooting direction. Push the joystick up/down and left/right allows manual control of the tilt axis and pan axis.

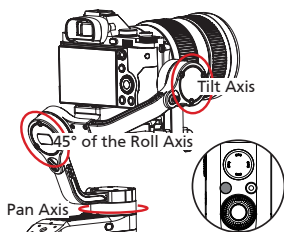

**Point of View Mode (POV):** Single press the POV mode button

This mode allows the camera to roll left/right at a Max. angle of 45° and all the three motors with unlimited 360° rotation following the movement of the stabilizer.

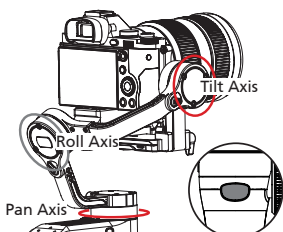

**Follow Mode (F):** Press the Mode button at the back

The camera pans and tilts following the movement of the stabilizer. Push the joystick left/right allows manual control of the roll axis.

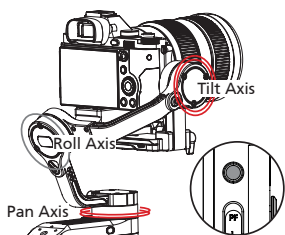

**PhoneGo Mode (GO):** Press the PhoneGo Mode button

The camera pans left/right and tilts up/down following the movement of the stabilizer in faster speed while the roll axis is locked.

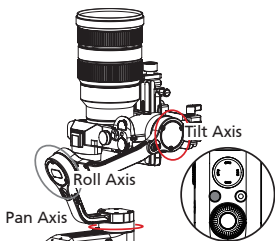

**Vortex Mode (V):** Double press the POV mode button

The camera tilts with a 90° angle following the movement of the handle while the roll axis is locked. Please use this mode in an underslung gesture and push the joystick right/left to rotate the pan axis.

Sling Mode

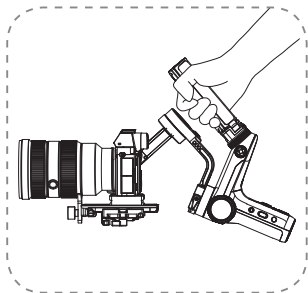

Upright Mode

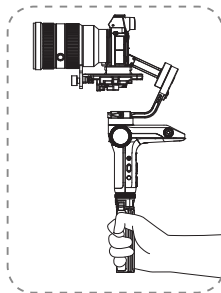

**⚠** Before using with Sling Mode, please be sure to put the tripod lock switch to lock.

## Manual Angle Lock

Under pan following mode and locking mode, you can manually rotate the camera to a certain angle, then loosen your grip and the camera position will be fixed. Under pan following mode, you can manually adjust the angle of tilt axis. Under locking mode, you can manually adjust the angle of pan axis and tilt axis.

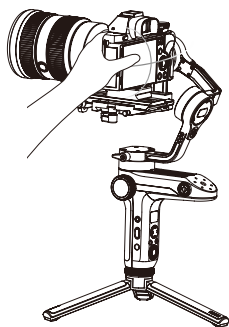

## Image Transmission System and APP Operations

1. WEEBILL LAB image transmission system can only be applied in combination with mobile APP "ZY Play".
2. Before using the image transmission system, please confirm that the camera control cable is properly connected.
3. For Sony camera, please confirm the USB connection setting of the camera is set as computer remote control mode, and the static image storage in the computer remote control is set as computer + camera device. Set LUMIX camera to PC (Tether) mode in USB mode.
4. With the TransMount Phone Holder with Crown Gear (needs to be purchased separately), it is easier to mount the phone on the stabilizer and adjust the viewing angle of the phone screen.

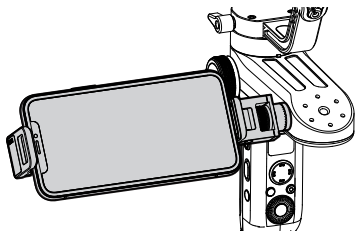

## Download APP



Scan the left QR code (Android 5.0 and above, IOS 9.0 and above) or search "ZY Play" directly in the app store to download "ZY Play".

1. Paired with the APP "ZY Play" designed for WEEBILL LAB, it can provide you better use of various functions.
2. The ZHIYUN APP is subject to regular update, try out now to discover more functions.

## How to Connect Stabilizer to Smartphone/Tablet

1. Power on the stabilizer and connect the stabilizer with the camera with the corresponding camera control cable. Turn on Bluetooth and WIFI on the mobile device.
2. Open "ZY Play" and select the product page corresponding to WEEBILL LAB. Click "connect device", and select the stabilizer with the corresponding Bluetooth name (the Bluetooth name WEEBILL LAB\_XXXX can be viewed in About).
3. After entering the APP's main interface, tap the WIFI icon (📶) and connect to the stabilizer WIFI according to the prompts (Initial default password 12345678).

## Overview of the Main Functions



## When to Calibrate the Stabilizer

Please calibrate the stabilizer when necessary.

Syndromes that requires calibration	How to calibrate
<ol style="list-style-type: none"> <li>1. Slight deviation is found in the tilt angle of the camera in level position after startup.</li> <li>2. Slight deviation is found in the roll angle of the camera in level position after startup.</li> <li>3. Frequent small angle correction is found when the camera is in level position while the stabilizer stays still.</li> </ol>	Initializing the stabilizer
<ol style="list-style-type: none"> <li>1. Slight deviation is found in the level position after the initialization of the stabilizer.</li> <li>2. The stabilizer has not been used for a long time.</li> <li>3. The stabilizer undergoes significant temperature difference in operation environments.</li> </ol>	Six-side calibration
Slight deviation is found in the tilt or roll angle of the camera in level position after initialization and six-side calibration of the stabilizer.	Fine tune motor force

## Initialization Method

1. Correctly install the batteries.
2. Hold the camera mounting plate with one hand, long press the power button to start up the stabilizer; long press the POV mode button to enter standby mode while keeping hold of the camera mounting plate through the whole process in case of start-up failure.
3. Put the stabilizer still on a table surface, and wait for about 30 sec, and the stabilizer will automatically complete initialization.



## Six-side Calibration

### Six-side calibration via OLED display guide

1. Power on the stabilizer and enter standby mode, then press menu and rotate the dial to "calibration" option. Press right to confirm selection.
2. As seen below, conduct six-side calibration following the 6 steps shown in the graphs, finish by pressing any button to exit the menu.

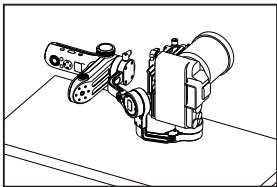

STEP 1

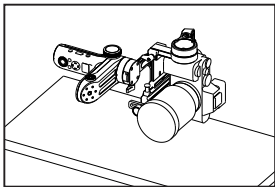

STEP 2

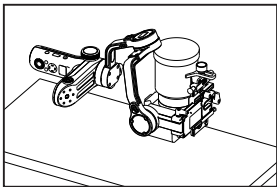

STEP 3

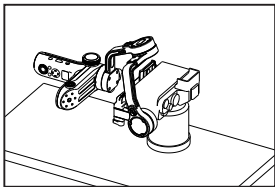

STEP 4

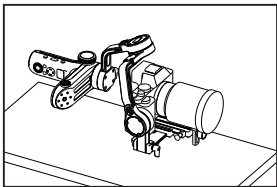

STEP 5

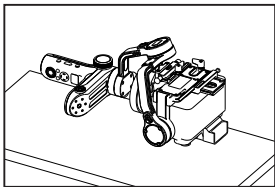

STEP 6

### Six-side calibration through APP

Connect the stabilizer to "ZY Play". Enter "Calibration" and finish six-side calibration following the APP instruction.

- 💡 Six-side calibration is simply to place six sides of the camera mounting plate respectively and sequentially in vertical to a level surface.

### Motor Fine-tuning

#### **Fine tune the motor through stabilizer:**

1. Power on the stabilizer and enter standby mode, then rotate the dial and press right to enter the "angle" option;
2. Adjust the value of the tilt and roll axis angle to your actual needs.

#### **Fine tune the motor through APP**

Connect the stabilizer to "ZY Play". Enter "Gimbal Settings", and adjust the value of the tilt and roll axis angle to your actual needs.

### Firmware Upgrade

"ZY Play" will automatically search for the latest firmware after the stabilizer is connected. Tap to upgrade automatically.

-  Before firmware upgrade, please ensure that the power level of both stabilizer and phone remain above 50%. Do not turn off the stabilizer during upgrade.

Product Model: CR104

	Min.	Standard	Max.	Remark
<b>Charging Voltage</b>	6.4V	-	8.4V	
<b>Charging Current</b>	250mA	-	3000mA	
<b>Output Voltage</b>	-	5V	-	
<b>Output Current (Micro USB port)</b>	-	500mA	-	
<b>Tilt Mechanical Range</b>	-	360°	-	Unlimited Rot
<b>Roll Mechanical Range</b>	-	360°	-	Unlimited Rot
<b>Pan Mechanical Range</b>	-	360°	-	Unlimited Rot
<b>Operation Temperature</b>	-10°	25°	45°	
<b>Battery Capacity</b>		2600mAh		Two 18650 Li-ion Batteries
<b>Battery Runtime</b>	6h	12h		Lab Data 1
<b>Charging Time</b>		2.5h		Lab Data 2
<b>Valid Payload</b>	300g		3000g	
<b>Bluetooth</b>			Bluetooth 5.0	
<b>WIFI</b>	Maximum effective range of image transmission signal in WIFI 2.4G: 50m (no occlusion, no interference)			

"Lab Data 1": The 12h runtime is concluded via a complete test session in which the stabilizer is well balanced with SONY A7+10-18 F4 lens installed. The ambient temperature is 25° and it is placed at rest throughout the test session.

"Lab Data 2" WEEBILL LAB automatically stops charging when the charging temperature is not within the reference temperatures in order to protect device and batteries. When the temperature is over 25°, please use 5V/2A power adapter to proceed this test. The charging time varies according to different environment and actual results may be different. When the charging temperature is lower, charging current value is smaller so charging time is extended. All data in this User Guide are generated in internal experiments of ZHIYUN lab. Under different circumstances, data may vary to some extent. Please refer to actual operation circumstances.

Note: The contents marked grey are for internal reference only. In different objective circumstances, the data will have different degrees of deviation, please take into consideration of actual operation circumstances while referring to the data thus provided.

Thank you for purchasing ZHIYUN WEEBILL LAB. The information contains herein affects your safety, legitimate rights and obligation. Please read this instruction carefully to ensure proper configuration before use. Failure to read and follow this instruction and warnings herein may result in serious injury to you or bystanders, or damage to your device or property. Guilin Zhishen Information Technology Co., Ltd. reserves all rights for final explanation on this instruction and other documents related to WEEBILL LAB. The information is subject to update without notice. Please visit [www.Zhiyun-tech.com](http://www.Zhiyun-tech.com) to obtain the latest product information.

By using this product, you hereby signify that you have read this document carefully and that you understand and agree to abide by the terms and conditions herein. You agree that you are solely responsible for your own conduct while using this product, and for any consequences thereof. You agree to use this product only for purposes that are proper and in accordance with all terms, precautions, practices, policies and guidelines ZHIYUN has made and may make available.

ZHIYUN accepts no liability for damage, injury or any legal responsibility incurred directly or indirectly from the use of this product. Users shall observe safe and lawful practices including, but not limited to, those set forth herein.

ZHIYUN™ is the trademark of Guilin Zhishen Information Technology Co., Ltd. (hereinafter referred to as “ZHIYUN” or “ZHIYUN TECH”) and its affiliates. All product names or marks referred to herein are trademarks or registered trademarks of their respective holders.

### Reading Tips

Legends:  Hints and Tips  Important

### Warnings

Read the ENTIRE User Guide to become familiar with the features of this product before operating. Failure to operate the product correctly can result in damage to the product or personal property and cause serious injury. This is a sophisticated product. It must be operated with caution and common sense and requires some basic mechanical ability. Failure to operate this product in a safe and responsible manner could result in injury or damage to the product or other property. This product is not intended for use by children without direct adult supervision. DO NOT use with incompatible components or in any way otherwise as mentioned or instructed in the product documents provided by ZHIYUN. The safety guidelines herein contain instructions for safety, operation and maintenance. It is essential to read and follow all of the instructions and warnings in the User Guide, prior to assembly, setup or use, in order to operate the product correctly and avoid damage or serious injury.

### Safe Operation Guidelines

#### ■ CAUTION:

1. WEEBILL LAB is a high-precision control device. Damage may be caused to WEEBILL LAB if it is dropped or subject to external force, and this may result in malfunction.
2. Make sure the rotation of the gimbal axes is not blocked by external force when WEEBILL LAB is turned on.
3. WEEBILL LAB is not waterproof. Prevent contacts of any kind of liquid or cleaner with WEEBILL LAB. It is recommended to use dry cloth for cleaning.
4. Protect WEEBILL LAB from dust and sand during use.

#### ■ WARNING

To avoid fire, serious injury, and property damage, observe the following safety guidelines when using, charging, or storing your batteries.

#### Battery Use

1. Prevent the batteries to come into contact with any kind of liquid. Do not leave batteries out in the rain or near a source of moisture. Do not drop the battery into water. If the inside of the battery comes into contact with water, chemical decomposition may occur, potentially resulting in the battery catching on fire, and may even lead to an explosion.
2. If the battery falls into water with the stabilizer during use, take it out immediately and put it in a safe and open area. Maintain a safe distance from the battery until it is completely dry. Never use the battery again, and dispose of the battery properly as described in the Battery Disposal section below.
3. If the battery catches fire, use water, water spray, sand, fire blanket, dry powder, or carbon dioxide fire extinguisher immediately to put out the fire. Battery-caused fire may lead to explosion. Please extinct the fire by applying the methods recommended above according to the actual situation.
4. Never use non-ZHIYUN batteries. If replacement or backup is needed, please purchase new batteries from ZHIYUN's official website or authorized channels. ZHIYUN takes no responsibility for any damage caused by non-ZHIYUN batteries.
5. Never use or charge swollen, leaky, or damaged batteries. Never use or charge if the battery smells, or overheats (exceeding maximum temperature of 160°F/71°C). If your batteries are abnormal, contact ZHIYUN or a ZHIYUN authorized dealer for further assistance.
6. The battery should be used within the temperature range from -10°C to 45°C. Use of battery in environments above 45°C may lead to a fire or explosion. Use of battery below -10°C may lead to serious battery damage.
7. Do not use the battery in strong electrostatic or electromagnetic environments. Otherwise, the battery protection board may malfunction.
8. Do not disassemble or use any sharp object to puncture the battery in any way. Otherwise, the battery may leak, catch fire or explode.

9. Do not mechanically strike, crush, or throw the battery. Do not place heavy objects on the battery or charger.
10. Electrolytes inside the battery are highly corrosive. In case of accidental contact of any electrolytes with your skin or eyes, rinse immediately with water for at least 15 minutes and seek medical advice as soon as possible.
11. Do not use the battery if it has been involved in a crash or heavy impact.
12. Do not heat the battery and never put the battery in a microwave oven or in a pressurized container.
13. Do not place the battery on a conductive surface (such as a metal desk surface, eye-glasses, watch, jewelry, etc.)
14. Prevent use of wires or other metal objects that could cause positive and negative short-circuit to the battery.
15. If the battery terminal is dirty, wipe it with a clean, dry cloth. Otherwise it will cause a bad battery connection, which may result in energy loss or charging failure.

### **Battery Charging**

1. The battery will automatically stop charging once it is full. Please disconnect the battery and the charger when fully charged.
2. Do not attach the batteries to a wall outlet or car charger socket directly. Always use a ZHIYUN approved adapter for charging. ZHIYUN takes no responsibility if the battery is charged using a non-ZHIYUN charger.
3. Do not put the battery and charger near flammable materials or on flammable surfaces (such as carpet or wood). Never leave the battery unattended during charging to prevent any accident.
4. Do not charge the battery immediately after use, because the battery temperature may be too high. Do not charge the battery until it cools down to normal room temperature. Charging the battery with its temperature over 45°C or lower than 0°C may lead to leakage, overheating, or damage.
5. Examine the charger before use, make sure there is no damage to the enclosure, cord, plug, or other parts. Never use a damaged charger. Do not clean the charger with any liquid containing alcohol or other flammable solvents. Disconnect the charger when not in use."

### **Battery Storage**

1. Keep batteries out of the reach of children and pets.
2. Do not leave the battery near heat sources such as a furnace or heater, or inside of a vehicle on hot days. Never expose the battery in any environment with temperature of over 60°C. The ideal storage temperature is 22°C-28°C.
3. Store batteries in a dry environment.
4. Do not leave the battery unused for too long after it has been completely discharged to prevent over-discharge of battery which may result in battery damage and permanent failure.

### **Battery Maintenance**

1. Do not over-charge or over-discharge the battery, which will damage the battery;
2. The battery performance will be affected for not being used for a long time;
3. Never use the battery when the temperature is too high or too low;
4. Do not store the battery in any environment with a temperature of over 60°C.

### **Battery Disposal**

1. Please fully discharge the battery before putting it in the designated recycling bin. Batteries contain hazardous constituents and it is forbidden to put the battery in general waste bin. For related details please abide by the local laws and regulations on battery recycling and disposal.
2. If the battery cannot be fully discharged, never put it in battery recycling bin. Please contact battery recycling companies for a proper solution.

---

 Search and follow “Zhiyun Tech” on Facebook, Instagram, Twitter, YouTube and Vimeo to connect with us.

Tel: +86 400 900 6868

USA Hotline: +1 808-319-6137,9:00-18:00 GMT-7,Mon-Fri

Europe Hotline: +49 0 61018132180,10:00-17:00 GMT+1,Mon-Fri

Web: [www.zhiyun-tech.com](http://www.zhiyun-tech.com)

E-mail: [service@zhiyun-tech.com](mailto:service@zhiyun-tech.com)

Address: 09 Huangtong Road, Tieshan Industrial Zone, Qixing District, Guilin, 541004, Guangxi, China

### Warranty Period

1. Customers are entitled to replacement or free repair service in case of quality defect(s) found in the product within 15 days upon receipt of the product.
2. Customers are entitled to free repair service from ZHIYUN for any product proven defective in material or workmanship that results in product failure during normal consumer usage and conditions within the valid warranty period, which is 12 months counting from the date of selling.
3. Some states or countries do not allow limitations on how long an implied warranty lasts, so the above warranty term may not apply to you.

### Exceptions

1. Products subjected to unauthorized repair, misuse, collision, neglect, mishandling, soaking, accident, and unauthorized alteration.
2. Products subjected to improper use or whose labels or security tags have been torn off or altered.
3. Products whose warranty has expired.
4. Products damaged due to force majeure, such as fire, flood, lightning, etc.

### Warranty Claim Procedure

1. If failure or any problem occurs to your product after purchase, please contact a local agent for assistant, or you can always contact ZHIYUN's customer service through email at [service@zhiyun-tech.com](mailto:service@zhiyun-tech.com) or website at [www.zhiyun-tech.com](http://www.zhiyun-tech.com).
2. Your local agent or ZHIYUN's customer service will guide you through the whole service procedure regarding any product issue or problem you have encountered. ZHIYUN reserves the right to reexamine damaged or returned products.



**Customer information**

Customer Name : Contact No :

Address :

**Sales Information**

Sales Date : Prod. Serial No :

Dealer :

Contact No :

**#1 Maintenance Record**

Service Date : Signature of Repairman :

Cause of Problem :

Service Result : Solved Unsolved Refunded (Replaced)

# Certificate of Quality

This product is confirmed to meet quality standards and permitted for sale after strict inspection.

QC Inspector: \_\_\_\_\_



Please download the latest version from [www.zhiyun-tech.com](http://www.zhiyun-tech.com)  
This document is subject to change without notice.  
ZHIYUN™ is a trademark of ZHISHEN.  
Copyright © 2020 ZHISHEN. All rights reserved.

ZHIYUN-TECH.COM