

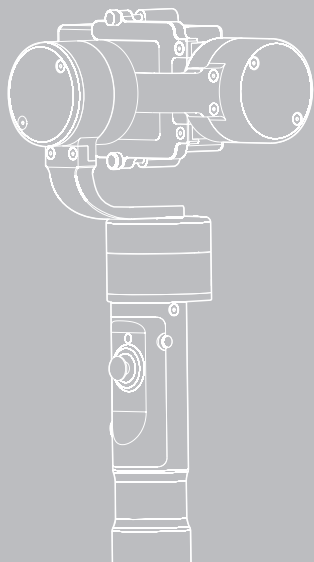

EVOLUTION

User Guide











Contents

■ Packing List	1
■ Disclaimer and Warning	2
■ Quick Start Guide	7
■ Control Panel	8
■ How to Start Up	9
■ Preparing and Charging the Batteries	10
■ Introducing Gimbal Control Modes	11
■ Connection Ports & Various Operations	12
■ Accessorie	15
■ Initialization	16
■ Off-line Calibration	17
■ Product Specifications	19
■ Warranty Card	20
■ Contact Card	22

Packing List

The product package comes with the following items. In case that any item is found missing, please contact ZHIYUN or your local selling agent.

	EVOLUTION 3-Axis Gimbal Stabilizer for GoPro	1		Camera Charging Cable	1
	Camera Protection Sticker for Pan Axis Motor	1		Micro USB Cable	1
	Battery Compartment	1		Video Output & Charging Cable	1
	Battery Charger	1		18650 Li-ion Battery	2

Thank you for using ZHIYUN EVOLUTION. The information contains herein affects your safety and your legal rights and responsibilities. Read this entire document carefully to ensure proper configuration before use. Failure to read and follow the instructions and warnings herein may result in serious injury to you or bystanders, or damage to your device or property.

ZHIYUN reserves the right of final explanation for this document and all relevant documents relating to EVOLUTION, and the right to make changes at any time without notice. Please visit www.zhiyun-tech.com for the latest product information.

By using this product, you hereby signify that you have read this document carefully and that you understand and agree to abide by the terms and conditions herein. You agree that you are solely responsible for your own conduct while using this product, and for any consequences thereof. You agree to use this product only for purposes that are proper and in accordance with all terms, precautions, practices, policies and guidelines ZHIYUN has made and may make available.

ZHIYUN™ accepts no liability for damage, injury or any legal responsibility incurred directly or indirectly from the use of this product. Users shall observe safe and lawful practices including, but not limited to, those set forth herein.

ZHIYUN™ is the trademark of Guilin Zhishen Information Technology Co., Ltd. (hereinafter referred to as "ZHIYUN" or "ZHIYUN TECH") and its affiliates. All product names or marks referred to hereunder are trademarks or registered trademarks of their respective holders.

Glossary

The following terms are used throughout the product literature to indicate various levels of potential harm when operating this product.

WARNING: Procedures, which if not properly followed, may incur property damage, grave accident, or serious injury.

CAUTION: Procedures, which if not properly followed, may incur property damage and serious injury.

NOTICE: Procedures, which if not properly followed, may incur property damage or minor injury.

Reading Tips

Legends:  Hints and tips

 Important.

Warning

Read the ENTIRE User Guide to become familiar with the features of this product before operating. Failure to operate the product correctly can result in damage to the product or personal property and cause serious injury. This is a sophisticated product. It must be operated with caution and common sense and requires some basic mechanical ability. Failure to operate this product in a safe and responsible manner could result in injury or damage to the product or other property. This product is not intended for use by children without direct adult supervision. DO NOT use with incompatible components or in any way otherwise as mentioned or instructed in the product documents provided by ZHIYUN. The safety guidelines herein contain instructions for safety, operation and maintenance. It is essential to read and follow all of the instructions and warnings in the User Guide, prior to assembly, setup or use, in order to operate the product correctly and avoid damage or serious injury.

Safe Operation Guidelines

■ CAUTION:

- 1)EVOLUTION is a high-precision control device. Damage may be caused to EVOLUTION if it is dropped or subject to external force, and this may result in malfunction.
- 2)Make sure the rotation of the gimbal axes is not blocked by external force when EVOLUTION is turned on.
- 3)EVOLUTION is not waterproof. Prevent contacts of any kind of liquid or cleaner with EVOLUTION. It is recommended to use dry cloth for cleaning.
- 4)Protect EVOLUTION from dust and sand during use.

■ NOTICE:

Keep the handle stable when EVOLUTION is powered on, as shaking may cause failure to start up.

Battery Safety Guidelines

1. Prevent the batteries to come into contact with any kind of liquid. Do not leave batteries out in the rain or near a source of moisture. Do not drop the battery into water. If the inside of the battery comes into contact with water, chemical decomposition may occur, potentially resulting in the battery catching on fire, and may even lead to an explosion.
2. If the battery falls into water with the stabilizer during use, take it out immediately and put it in a safe and open area. Maintain a safe distance from the battery until it is completely dry. Never use the battery again, and dispose of the battery properly as described in the Battery Disposal section below.
3. If the battery catches fire, use water, water spray, sand, fire blanket, dry powder, or carbon dioxide fire extinguisher immediately to put out the fire. Please exting the fire by applying the methods recommended above according to the actual situation.
4. Never use non-ZHIYUN batteries. If replacement or backup is needed, please purchase new batteries from ZHIYUN's official website or authorized channels. ZHIYUN takes no responsibility for any damage caused by non-ZHIYUN batteries.
5. Never use or charge swollen, leaky, or damaged batteries. Never use or charge if the battery smells, or overheats (exceeding maximum temperature of 160° F / 71° C). If your batteries are abnormal, contact ZHIYUN or a ZHIYUN authorized dealer for further assistance.
6. The battery should be used within the temperature range from -10 ° C to 50 ° C. Use the battery in environments above 50° C can lead to a fire or explosion. Use of battery below -10° C can lead to serious battery damage.
7. Do not use the battery in strong electrostatic or electromagnetic environments. Otherwise, the battery protection board may malfunction.
8. Do not disassemble or use any sharp object to puncture the battery in any way. Otherwise, the battery may leak, catch fire or explode.
9. Do not mechanically strike, crush, or throw the battery. Do not place heavy objects on the battery or charger.
10. Electrolytes inside the battery are highly corrosive. In case of accidental contact of any electrolytes with your skin or eyes, rinse immediately with water for at least 15 minutes and seek medical advice as soon as possible.
11. Do not use the battery if it has been involved in a crash or heavy impact.
12. Do not heat the battery and never put the battery in a microwave oven or in a pressurized container.

13. Do not place the battery cell on a conductive surface (such as a metal desk surface).
14. Prevent use of wires or other metal objects that could cause positive and negative short-circuit to the battery.
15. If the battery terminal is dirty, wipe it with a clean, dry cloth. Otherwise it will cause a bad battery connection, which may result in energy loss or charging failure.

Battery Charging

1. Do not attach the batteries to a wall outlet or car charger socket directly. Always use a ZHIYUN approved adapter for charging. ZHIYUN takes no responsibility if the battery is charged using a non-ZHIYUN charger.
2. Do not put the battery and charger near flammable materials or on flammable surfaces (such as carpet or wood). Never leave the battery unattended during charging to prevent any accident.
3. Do not charge the battery immediately after use, because the battery temperature may be too high. Do not charge the battery until it cools down to normal room temperature. Charging the battery with its temperature over 40° C or lower than 15° C may lead to leakage, overheating, or damage.
4. Examine the charger before use, make sure there is no damage to the enclosure, cord, plug, or other parts. Never use a damaged charger. Do not clean the charger with any liquid containing alcohol or other flammable solvents. Disconnect the charger when not in use.

Battery Storage

1. Keep batteries out of the reach of children and pets.
2. Do not leave the battery near heat sources such as a furnace or heater, or inside of a vehicle on hot days. Never expose the battery in any environment with temperature of over 60 ° C. The ideal storage temperature is 22° C-28° C.
3. Store batteries in a dry environment.
4. Do not leave the battery unused for too long after it has been completely discharged to prevent over-discharge of battery which may result in battery damage and permanent failure.

Battery Maintenance

1. Never use the battery when the temperature is too high or too low.
2. Do not store the battery in any environment with a temperature of over 60° C.

Transportation Notice

1. Discharge the battery power to 5% or lower before carrying the battery on an airline flight. Only discharge the battery in a fireproof location, ideally in a dry and open area.
2. Do not store or transport batteries together with metal objects such as eyeglasses, watch, and jewelries, etc.

3. Do not transport damaged batteries. When transporting, be sure to discharge the battery to less than 50%.

Battery Disposal

Dispose of the battery in specific recycling boxes only after a complete discharge. Do not put away the battery in regular trash containers. Strictly follow your local regulations regarding the disposal and recycling of batteries.

NOTICE**Battery Use**

Make sure the batteries are fully charged before each time of use.

Battery Charging

The battery will stop charging automatically when it is full. Disconnect the batteries from the charger when fully charged.

Battery Storage

1. Discharge the battery to 40%-65% if it will NOT be used for over 10 days. This can greatly extend the battery life.
2. The battery enters hibernation mode when voltage gets too low. Charge the battery will bring it out of hibernation.
3. Remove batteries from the stabilizer when not in use and store them in a specialized container.

Battery Disposal

If the battery cannot be fully discharged, do not leave it in the recycling box, but contact a professional battery disposal/recycling agent for further assistance.

This document is subject to change.

ZHIYUN™ is a trademark of ZHISHEN TECH.

Copyright © 2017-2018 ZHISHEN TECH. All rights reserved.

Get to Know EVOLUTION

Check the product package before use, make sure that all items below have arrived with the product. In case that any item is found missing, please contact ZHIYUN or your local selling agent.

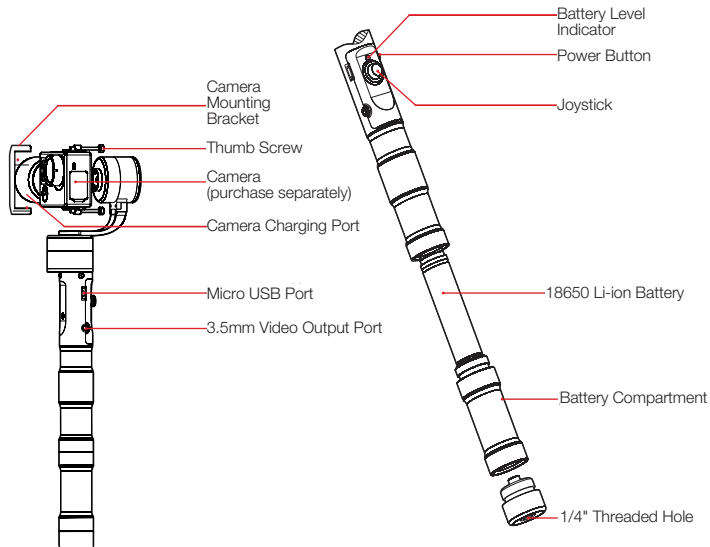

Control Panel Introduction

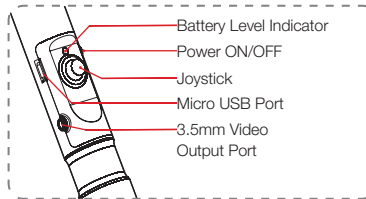

Battery Level Indicator: Indicates current power level with different flashing frequency.

Power ON/OFF: Long press 3 sec. to Power ON/OFF.

Joystick: Controls the camera movement and switches between modes.

Micro USB Port: Connect the stabilizer with a computer for firmware upgrade and on-line calibration.

3.5mm Video Output Port: Used for real-time video output and camera charging.

How to Start Up

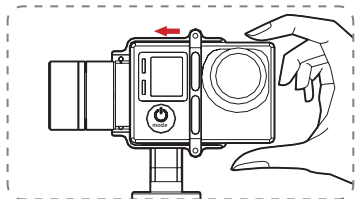

1. Push to mount the camera until it touch against the tilt axis motor.

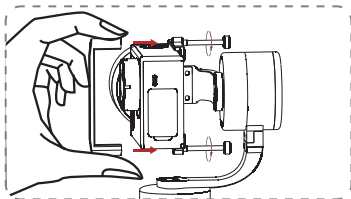

2. Rotate the Thumb Screws to tighten up the camera mounting bracket.

■ NOTICE: Do not power on the stabilizer before the camera is properly mounted.

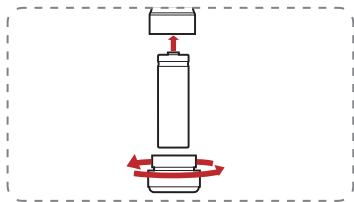

3. Loosen the end cover, rotate the battery compartment to the handle, and then install the two batteries. Tighten up the end cover.

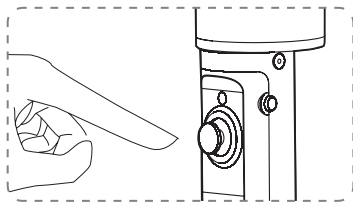

4. Single press the Power button. The Battery Level Indicator blinks for a second and shines solid light while the stabilizer enters standby mode.

5. Long press the Joystick for about 3 sec. to activate the stabilizer. Now, your EVOLUTION is ready for use.

■ NOTICE: Make sure to tighten the end cover properly after battery installation, or the stabilizer cannot be turned on.

Preparing and Charging the Batteries

Before using EVOLUTION for the first time, please fully charge the batteries to activate and ensure normal operation by using the charger that comes in the package.

Name: Li-ion battery charger

Model: ZC-18650

Input: DC 5V 1600mA

Output: DC 4.2V 800mA

- Shines solid RED light when charging
- Shines BLUE light when fully charged.

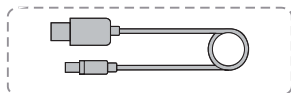
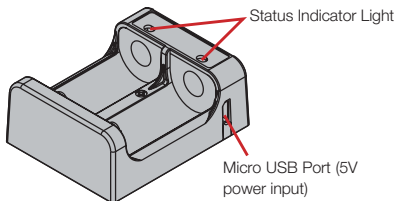

18650 Li-ion Battery
Capacity: 2000mAh
Voltage: 3.7V

■ NOTICE

- 1.The charger is for charging ZHIYUN's IMR 18650 Li-ion Battery only. Do not charge batteries of other models or brands, otherwise it may lead to accident.
- 2.Use qualified 5V adapter with output current of $\geq 800\text{mA}$ only. Charging time depends on the max. output current of the adapter.

Please use and charge batteries provided or approved by ZHIYUN only. ZHIYUN will not take any responsibility for explosion, fire and/or accidents caused by non-ZHIYUN batteries.

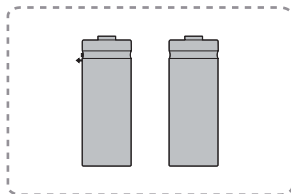

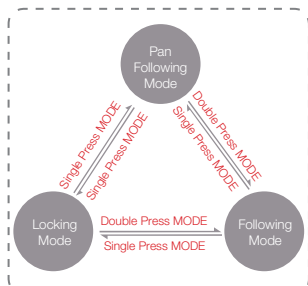

Mode Switch Schematic Figure

Mode switch:

The stabilizer enters Pan Following Mode by default each time when powered on. Switch into Locking Mode by single pressing on the Joystick. Double press the Joystick to enter the Following mode. Single press the Joystick under the Following Mode will return to the previous mode.

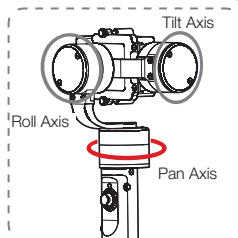

Pan Following Mode: The camera pans left/right following the movement of the stabilizer while the tilt and roll axes are locked. Push the joystick up/down allows manual control of the tilt axis.

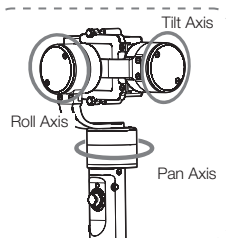

Locking Mode: This mode locks movement of all three axes to keep the camera still and stable. Push the joystick up/down and left/right allows manual control of the tilt axis and pan axis.

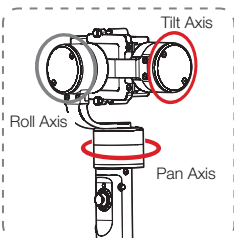

Following Mode: The camera pans and tilts following the movement of the stabilizer. Push the joystick left/right allows manual control of the roll axis.

Micro USB Port

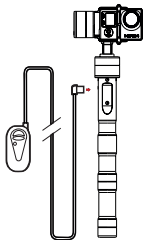

1. Connect the stabilizer to your computer using the Micro USB cable for firmware upgrade and on-line calibration.
2. Connect the stabilizer to a specialized wired remote commander.

■ NOTICE

This port cannot be used for charging.

Firmware Upgrade

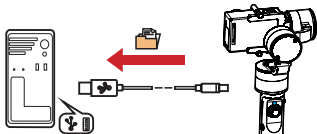

1. Visit ZHIYUN's official website: www.zhiyun-tech.com.
2. Click to open the "Downloads" page, and find the Firmware Upgrade Tutorial package.
3. Download the driver, calibration tool and latest firmware corresponding to your stabilizer.
4. Upgrade firmware following the instructions indicated in the Firmware Upgrade Tutorial.

NOTICE: Make sure batteries are installed during upgrade.

Battery Level Indicator

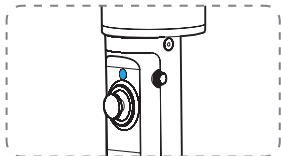

Definition of Battery Level Indicator Status

Indicator Status	Battery Level
Quick flash 4 times	76%-100%
Quick flash 3 times	51%-75%
Quick flash 2 times	26%-50%
Quick flash 1 time	1%-25%

Main Operations

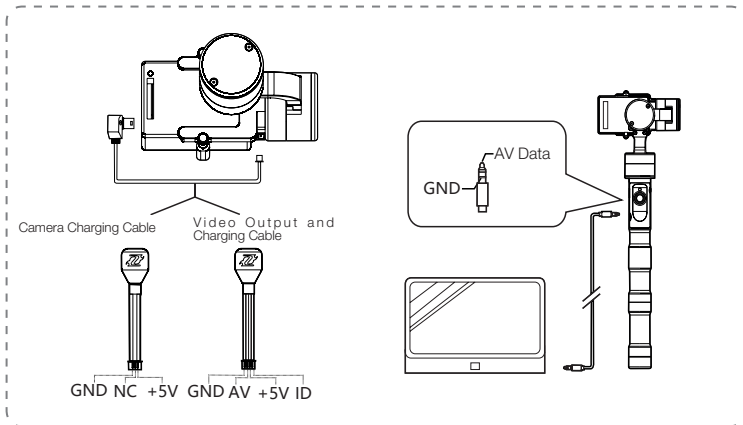

A.Camera Charging: Users can charge the camera by connecting it with the stabilizer via the charging cable.

B.Video Output (for real-time display monitor)

1)Power up the stabilizer and connect the stabilizer with the camera using the Video Output & Charging Cable.

2)Connect the stabilizer with a display screen using a 3.5mm Video Output Cable (purchase separately).

Remote Control

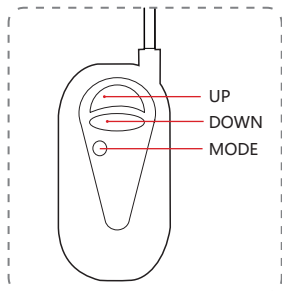

1. Application: For wired remote control of EVOLUTION.
- 2.Connection: Connect to the Micro USB port of the stabilizer.
- 3.Button Operations:
MODE - Switches between the three Gimbal Control Modes.
UP & DOWN - Command the Tilt Axis to tilt up/down in Pan Following & Locking Modes; Command the Roll Axis to roll left/right in Following Mode.

■ NOTICE

The remote control is not included in product package, please purchase separately.

Initializing the Stabilizer

Initialize the stabilizer when any of the following circumstances occurs:

- a) Slight deviation is found in the tilt angle of the camera in level position after startup.
- b) Slight deviation is found in the roll angle of the camera in level position after startup.
- c) Frequent small angle correction is found when the camera is in level position while the stabilizer stays still.

Initialization Procedure

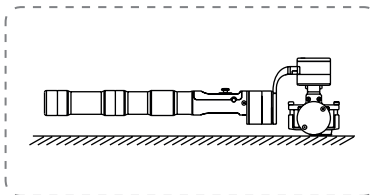

1. Install the batteries and camera properly.
2. Put the stabilizer still on a table surface in random pose.
3. Power on the stabilizer, wait for about 15 sec., and the stabilizer will automatically complete initialization.

If slight deviation can still be found after initialization, repeat the procedure above to initialize again.

Off-line Calibration

Calibrate the stabilizer when any of the following circumstances occurs:

1. Deviation is found in the balancing of the camera even after initialization.
2. The stabilizer has not been used for a long time.
3. The stabilizer is exposed to severe temperature change (Calibration is required, as excessive temperature differences in operation environments may affect various parameter indexes of the inner part of the built-in gyroscope).

Calibration Procedure

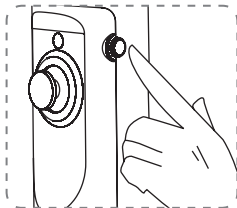

1. Power up the stabilizer. The Battery Level Indicator lights up in solid BLUE and then starts flashing as the stabilizer enters standby mode.

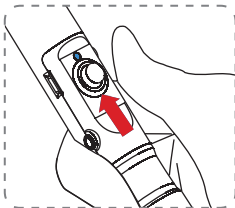

2. Push the Joystick up for one 1 sec. until the Indicator shines solid BLUE.

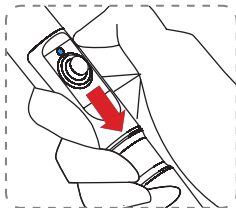

3. Push the Joystick down for one 1 sec. until the Indicator starts flashing (once each second). Now, it is ready for calibration.

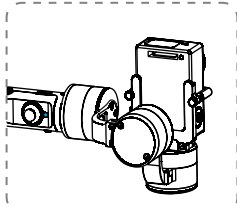

4. Lay the stabilizer still on a surface with the Tilt Axis Motor facing down, until the Indicator starts flashing 2 times each second.

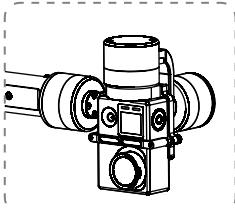

5. Lay the stabilizer still on a surface with the Tilt Axis Motor facing up, until the Indicator starts flashing 3 times each second.

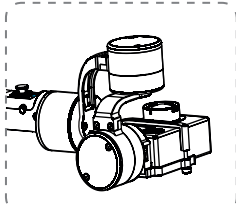

6. Lay the stabilizer still on a surface with the Mobile Clamp facing down, until the Indicator starts flashing 4 times each second.

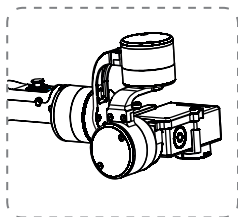

7. Lay the stabilizer still on a surface with the Mobile Clamp facing up, until the Indicator starts flashing 5 times each second.

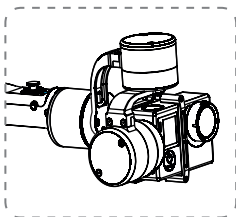

8. Lay the stabilizer still on a surface with the Mobile Clamp facing forward, until the Indicator starts flashing 6 times each second.

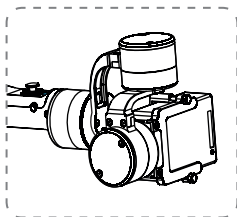

9. Lay the stabilizer still on a surface with the Mobile Clamp facing backward, until the Indicator shines solid BLUE. Calibration complete!

Parameter Specifications

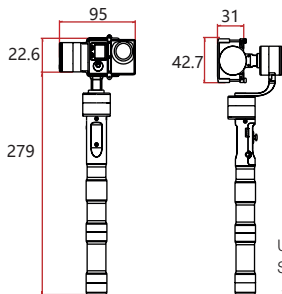

Unit: mm

Supported max. camera size:
42.7 x 31mm (1.7 x 1.2 inch)

Specifications

	Min	Standard	Max	Remarks
Input Vol	6.8V		12.6V	
Operation Current	50mA	80mA	3000mA	
Operation Temperature	-10° C	25° C	45° C	
Battery Runtime	11h	13h	15h	Tested under static operation after proper balancing
Weight		310g		Excluding batteries
Tilt Angle Range		320°		Handle in Vertical
Roll Angle Range		270°		
Pan Angle Range		320°		Handle in Vertical
Payload			160g	Excluding batteries

Warranty Period

1. Customers are entitled to replacement or free repair service in case of quality defect(s) found in the product within 15 days upon receipt of the product.
2. Customers are entitled to free repair service from ZHIYUN for any product proven defective in material or workmanship that results in product failure during normal consumer usage and conditions within the valid warranty period, which is 12 months counting from the date of delivery.
3. Some states or countries do not allow limitations on how long an implied warranty lasts, so the above warranty term may not apply to you.

This warranty does not apply to the followings

1. Products subjected to unauthorized repair, misuse, collision, neglect, mishandling, soaking, accident, and unauthorized alteration.
2. Products subjected to improper use or whose labels or security tags have been torn off or altered.
3. Products whose warranty has expired.
4. Products damaged due to force majeure, such as fire, flood, lightning, etc.

Warranty Claim Procedure

1. If failure or any problem occurs to your product after purchase, please contact a local agent for assistant, or you can always contact ZHIYUN's customer service through email at service@zhiyun-tech.com or website at www.zhiyun-tech.com.
2. Your local agent or ZHIYUN's customer service will guide you through the whole service procedure regarding any product issue or problem you have encountered.
3. ZHIYUN reserves the right to reexamine damaged or returned products.

Customer information

Customer Name :

Contact No :

Address :

Sales Information

Sales Date :

Prod. Serial No :

Dealer

Contact No :

#1 Maintenance Record

Service Date :

Signature of Repairman :

Cause of Problem :

Service Result :

Solved

Unsolved

Refunded(Replaced)





Website



Weibo



Vimeo



Google+



Facebook



Wechat



Youku



Youtube

Tel: +86-773-2320856

Web: www.zhiyun-tech.com

E-mail: service@zhiyun-tech.com

Address: Creative Industrial Park, GuiMo Road, QiXing District, Guilin
541004, Guangxi, China.

Certificate of Quality

This product is confirmed to meet quality standards and permitted for sale after strict inspection.

QC Inspector: _____



Please download the latest version from www.zhiyun-tech.com

This document is subject to change.

ZHIYUN™ is a trademark of ZHISHEN.

Copyright © 2017-2018 ZHISHEN. All rights reserved.



让时间更美好

zhiyun-tech.com